

STATIC DIMENSIONS

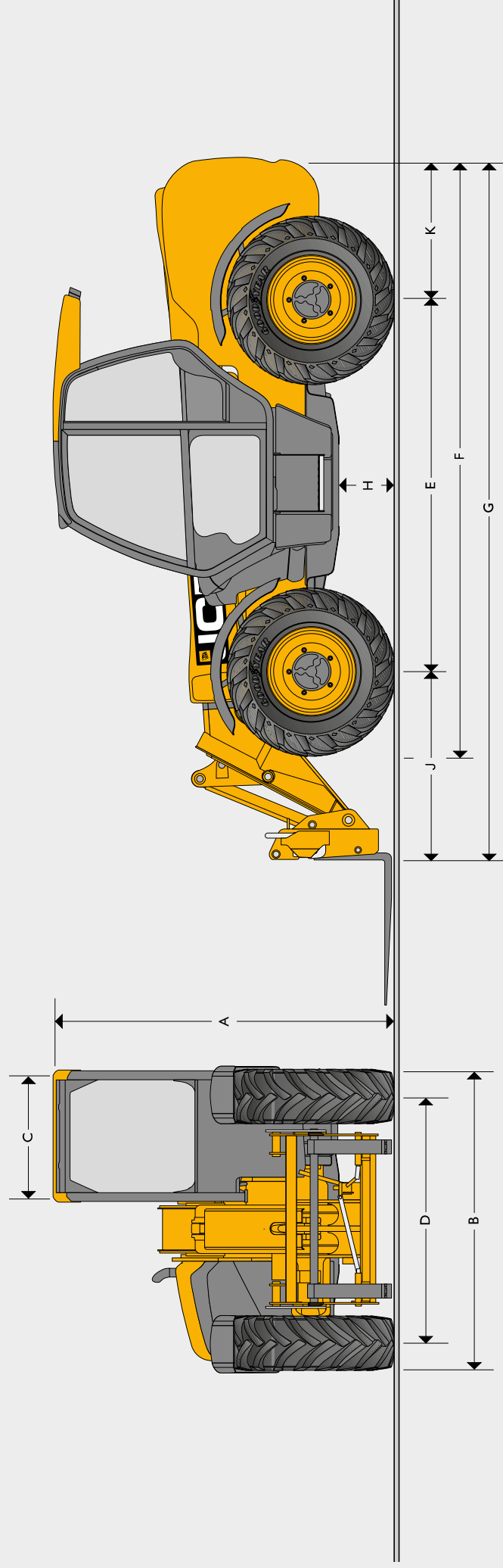

STATIC DIMENSIONS

Machine model	531-70	541-70	535-95	533-105	535-125 HiViz	540-140 HiViz	540-170	540-180 HiViz	540-200
A Overall height	m 2.49	2.49	2.49	2.49	2.59	2.59	2.69	2.59	2.72
B Overall length (over tyres)*	m 2.23	2.23	2.36	2.36	2.35	2.35	2.44	2.35	2.44
C Inside width of cab	m 0.94	0.94	0.94	0.94	0.94	0.94	0.94	0.94	0.94
D Front track	m 1.81	1.81	1.87	1.87	1.90	1.90	1.90	1.90	1.97
E Wheelbase	m 2.75	2.75	2.75	2.75	2.75	2.75	2.75	2.75	2.75
F Overall length to front tyres	m 4.38	4.38	4.38	4.38	4.74	4.74	5.08	4.75	5.09
G Overall length to front carriage	m 4.99	4.99	4.99	5.38	5.80	6.23	6.36	6.27	6.81
H Ground clearance	m 0.40	0.40	0.40	0.40	0.40	0.40	0.40	0.40	0.41
J Front wheel centre to carriage	m 1.25	1.25	1.20	1.62	1.68	2.11	1.94	2.15	2.39
K Rear wheel centre to rear face	m 0.99	0.99	1.04	1.01	1.37	1.37	1.67	1.37	1.67
Overall width with stabilisers fully deployed	m NA	NA	NA	2.63	2.57	2.57	3.55	3.39	3.82
Outside turn radius (over tyres)	m 3.7	3.7	3.7	3.7	3.75	3.75	4.10	3.75	4.1
Carriage rollback angle	degrees 42.6	42.6	41.0	41.2	37.0	37.0	39	36.50	39
Carriage dump angle	degrees 37.5	37.5	24.0	24.0	12.5	12.5	8.8	12.50	8.8
Weight	kg 7060	7850	8215	8850	10066	10880	12060	11380	12985
Tyres	15.5/80-24	15.5/80-24	15.5/80-24	15.5/80-24	15.5/80-24	15.5/80-24	15.5/80-24	15.5-25	17.5-25

* Type dependent

LIFT PERFORMANCE

	531-70	541-70	535-95	535-95 Sway
Maximum lift capacity	3 100 kg	4 100 kg	3 500 kg	3 500 kg
Lift capacity at full height	2 400 kg	2 250 kg	1 600 kg	1 600 kg
Lift capacity at full reach	2 700 kg	1 500 kg	500 kg	500 kg
Lift height	7.0 m	7.0 m	9.50 m	9.50 m
Reach at maximum lift height	0.54 m	0.54 m	2.49 m	2.49 m
Maximum forward reach	3.7 m	3.7 m	6.52 m	6.52 m
Reach with 1 tonne load	3.7 m	3.7 m	5.08 m	5.08 m
Placing height	6.3 m	6.3 m	8.78 m	8.78 m
Complies with stability test EN 1459 Annex B, Chassis Levelling (Sway) with stabilisers retracted (Sway angle $\pm 9^\circ$).				
	533-105 Stabilisers retracted	533-105 Stabilisers extended	535-125 HViz Stabilisers retracted Sway	535-125 HViz Stabilisers extended Sway
Maximum lift capacity	3 300 kg	3 300 kg	3 500 kg	3 500 kg
Lift capacity at full height	1 000 kg	2 500 kg	1 500 kg	3 500 kg
Lift capacity at full reach	375 kg	1 000 kg	200 kg	2 500 kg
Lift height	10.22 m	10.22 m	11.6 m	12.27 m
Reach at maximum lift height	2.69 m	1.99 m	2.01 m	0.54 m
Maximum forward reach	6.83 m	6.83 m	8.06 m	8.06 m
Reach with 1 tonne load	6.83 m	6.83 m	5.31 m	8.06 m
Placing height	9.44 m	9.82 m	11 m	11.75 m
Complies with stability test EN 1459 Annex B, Chassis Levelling (Sway) with stabilisers retracted (Sway angle $\pm 9^\circ$).				

LIFT PERFORMANCE

LIFT PERFORMANCE

540-140 HiViz Stabilisers retracted Sway

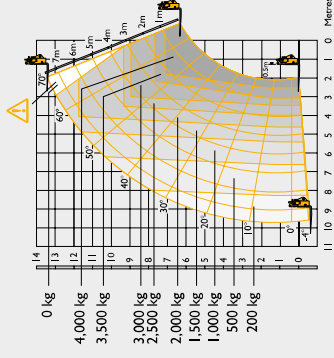

540-140 HiViz Stabilisers extended Sway

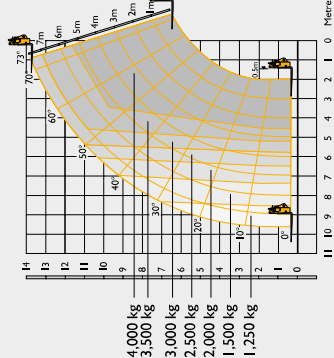

540-170 Stabilisers retracted Sway

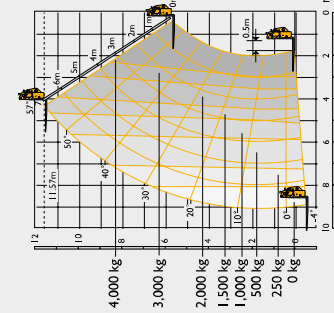

540-170 Stabilisers extended Sway

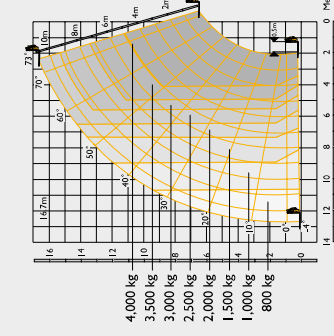

Maximum lift capacity	kg	4000
Lift capacity to full height	kg	1500
Lift capacity at full reach	kg	200
Lift height	m	12.89
Reach at maximum lift height	m	3.09
Maximum forward reach	m	9.70
Reach with 1 tonne load	m	6.61
Placing height	m	12.40

Complies with stability test EN 1459 Annex B. Chassis Levelling (Sway) with stabilisers retracted (Sway angle $\pm 9^\circ$).

LIFT PERFORMANCE

540-180 HiViz Stabilisers retracted Sway

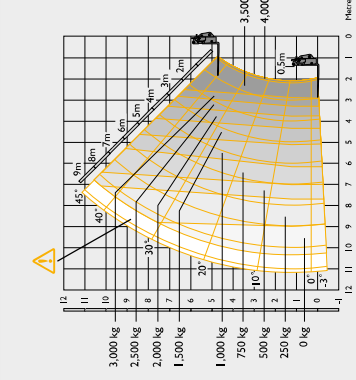

540-180 HiViz Stabilisers extended Sway

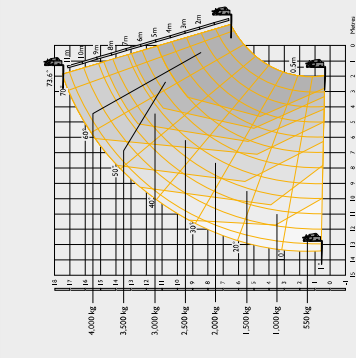

540-200 Stabilisers retracted Sway

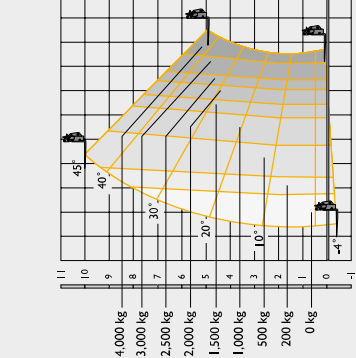

540-200 Stabilisers extended Sway

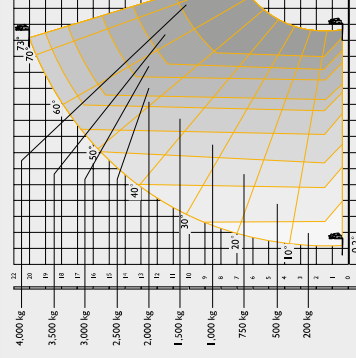

Maximum lift capacity	kg	4000
Lift capacity to full height	kg	500
Lift capacity at full reach	kg	0
Lift height	m	10.69
Reach at maximum lift height	m	6.92
Maximum forward reach	m	10.47
Reach with 1 tonne load	m	6.25
Placing height	m	10.0

Complies with stability test EN 1459 Annex B. Chassis Levelling (Sway) with stabilisers retracted (Sway angle $\pm 9^\circ$).

LIFT PERFORMANCE

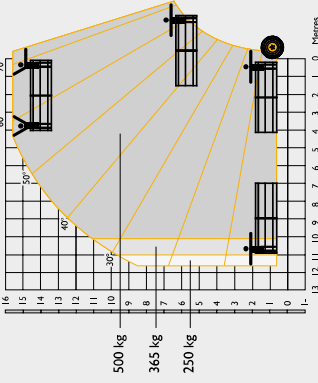
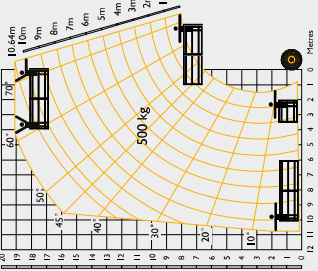
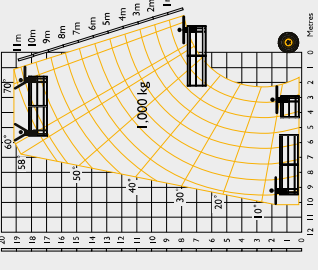
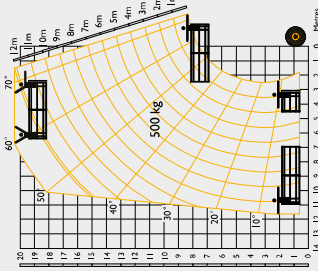
	540-140 HiViz Man platform Stabilisers extended	540-170 HiViz Man platform Stabilisers extended	540-180 HiViz Man platform Stabilisers extended	540-200 HiViz Man platform Stabilisers extended
				
Machine capacity	kg	4000	365kg basket	500kg basket
Personnel work height	m	15.6	4000	4000
Personnel work reach at maximum reach	m	11.75	19.25	19.25
Platform rated capacity	kg	500	13.16	12.17
Capacity at full reach	kg	365	365	500
Maximum forward reach (slewed platform)	m	11.14	365 @ 13.16m	500 @ 12.17m
Capacity to full working height	kg	500	12.5	11.5
		500	365	500
			1000kg basket	1000kg basket
			4000	4000
			19.25	19.25
			10.18	10.18
			1000	500
			1000 @ 10.18m	500 @ 11.63m
			10.18m	11.12
			1000	500

POINT LOADS

At maximum machine lift capacity (i.e. 4 tonne on a 540-170)

	531-70	541-70	535-95	533-105	535-125 HiViz	540-140 HiViz	540-170	540-180 HiViz	540-200
Load per front wheel	kg	4731	5540	5565	6365	6880	7541	6560	7723
Load per rear wheel	kg	441	480	476	415	415	610	1131	730
Load per stabiliser	kg	N/A	N/A	4188	5151	6010	5824	6243	5760
With no load on the forks and boom retracted in travel position									
Load per front wheel	kg	1803	1847	2312	2499	2484	2694	2608	2992
Load per rear wheel	kg	1819	2200	2078	2530	3060	3457	3462	3462